

RoHS Compliant

REV	MODIFICATION	DATE	DRAW	APPROVE

Mechanical:

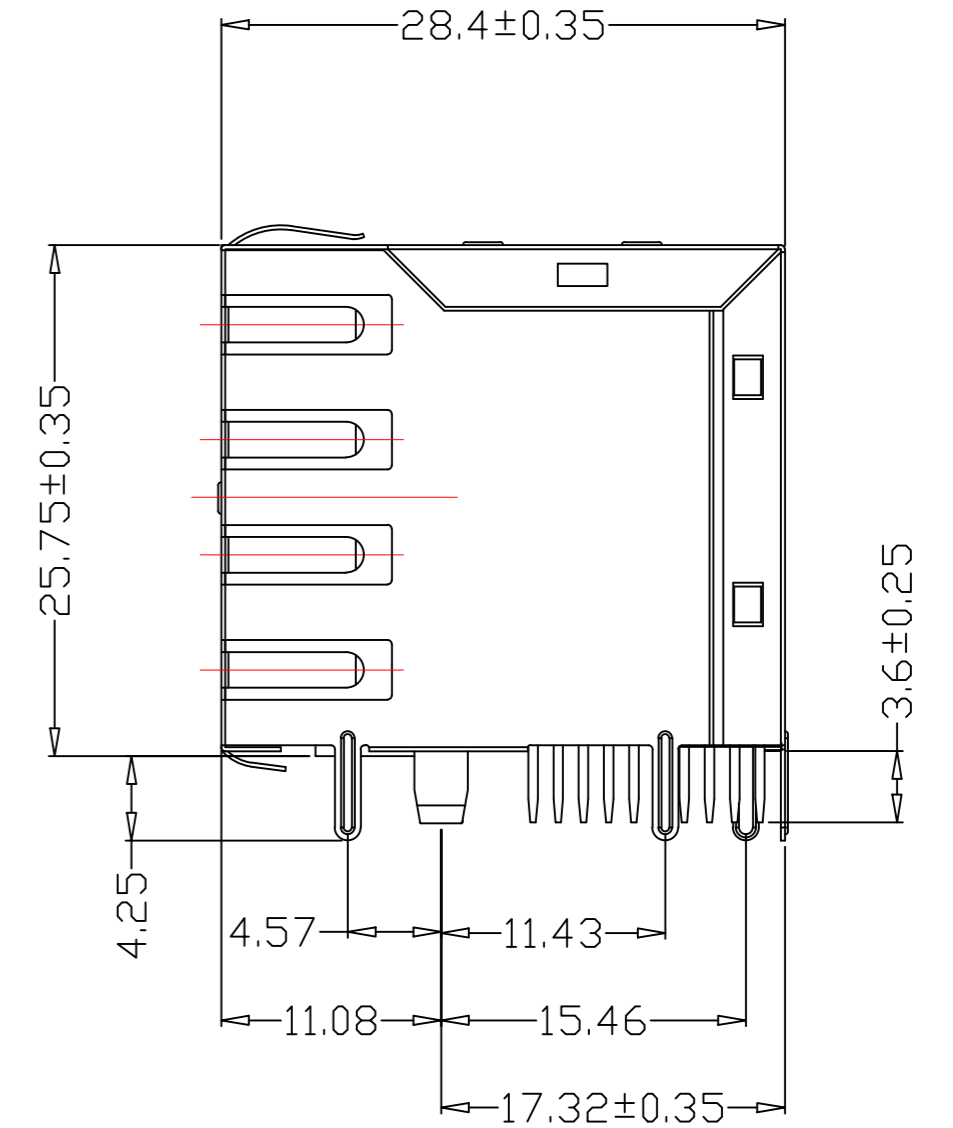
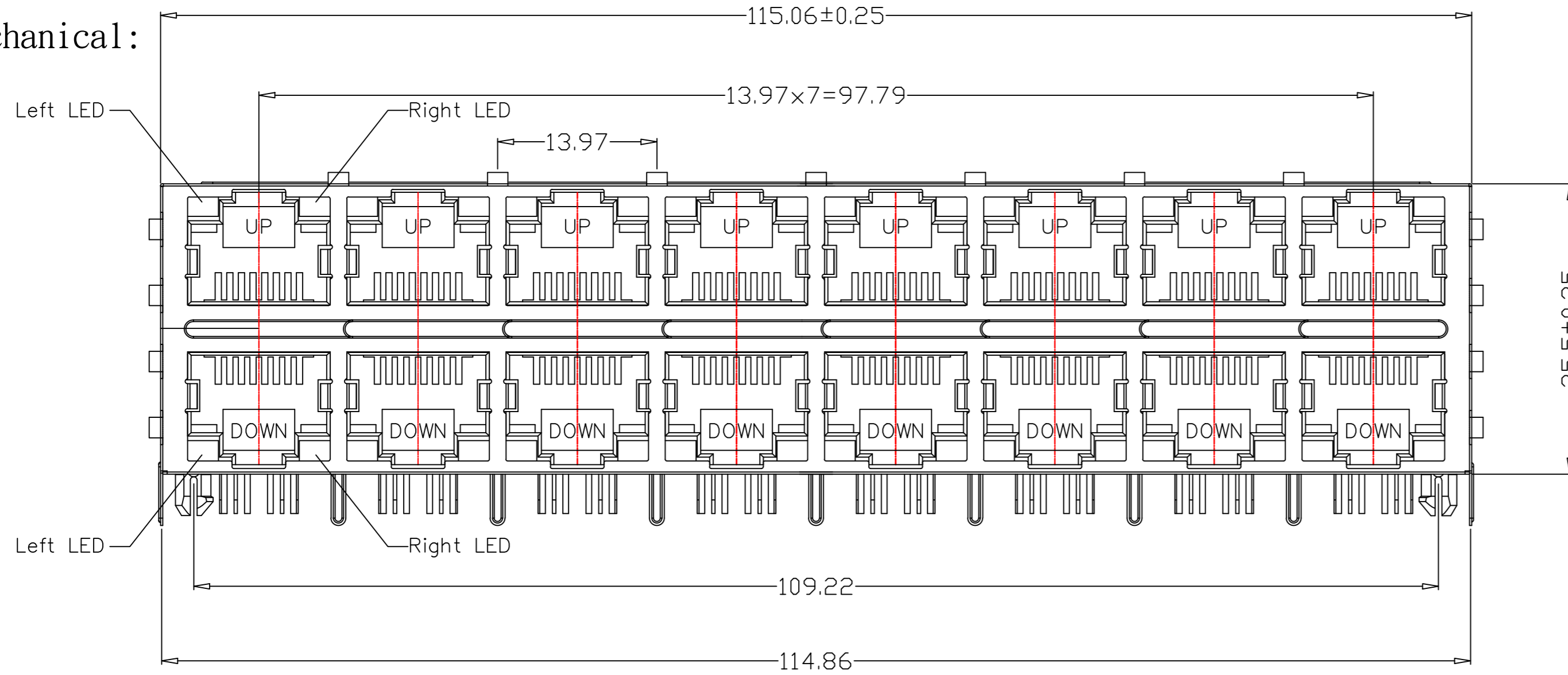

NOTE:

1. Shielded - 0.20mm THICKNESS BRASS C2680 H. PLATING NICKEL 30u"-50u".
2. Housing- Standard Material Nylon66, Glass Filled Polyester UL94V-0 Standed Color Black.
3. Insert Pin- Plastic: PBT+30% GF UL94V-0, Standard Color Black. Pin: 0.35mm Thickness Phos-Bronze C5210 EH. Plating: Nickel 40u"~60u" for all and Sn 100% , and Gold Plating.
4. Contact Pin- Plastic: Nylon66, Glass Filled, UL94V-0, Standard Color Black. Pin: 0.35mm Thickness Phos-Bronze C2680. Plating: Nickel 40u"~60u" for all and Sn 100%.

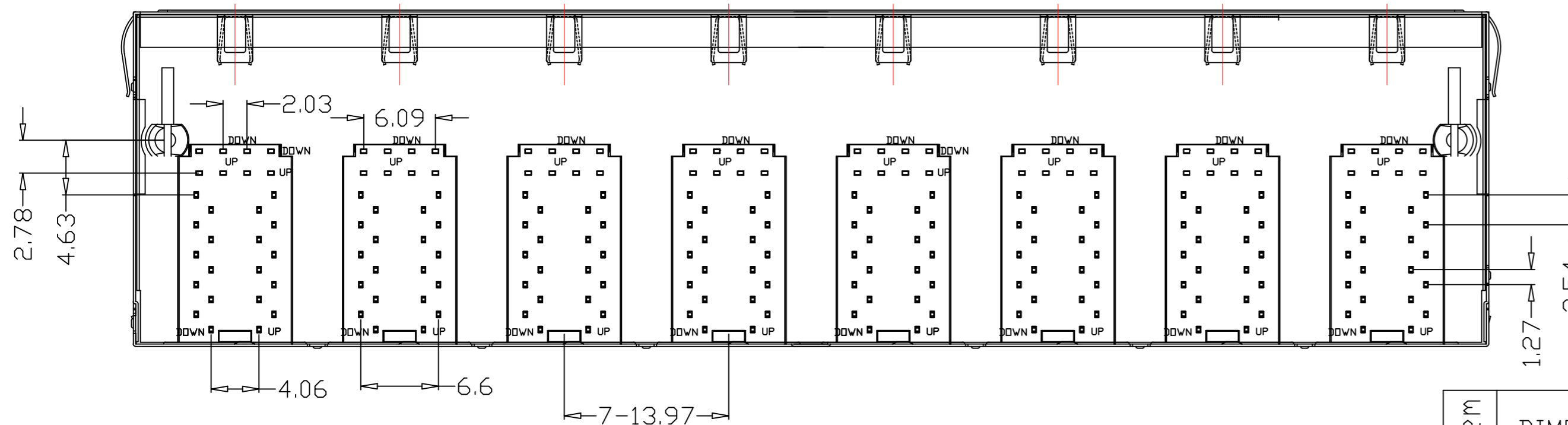

QC Inspection Item	DIMENSION IN mm [Inch]		ELLAX CORPORATION								
	TOLERANCE UNLESS OTHERWISE SPECIFIED		TITLE <b>2x8 2.5G Base-T</b>								
	.X ± 0.38	X.° ± 2.0°	DRAWING NUMBER 728EG2JSRA2								
	.XX ± 0.20	.X° ± 1.0°	DRAW KONGLEI 2018,10,04								
.XXX ± 0.10		APPROVE Corey 2018,10,04		CHECK Alen 2018,10,04		DRAW KONGLEI 2018,10,04		PRJ. SCALE 1:1		SHEET X OF Y SIZE A3	
								REV P1			

RoHS Compliant

REV	MODIFICATION	DATE	DRAW	APPROVE

Mechanical:

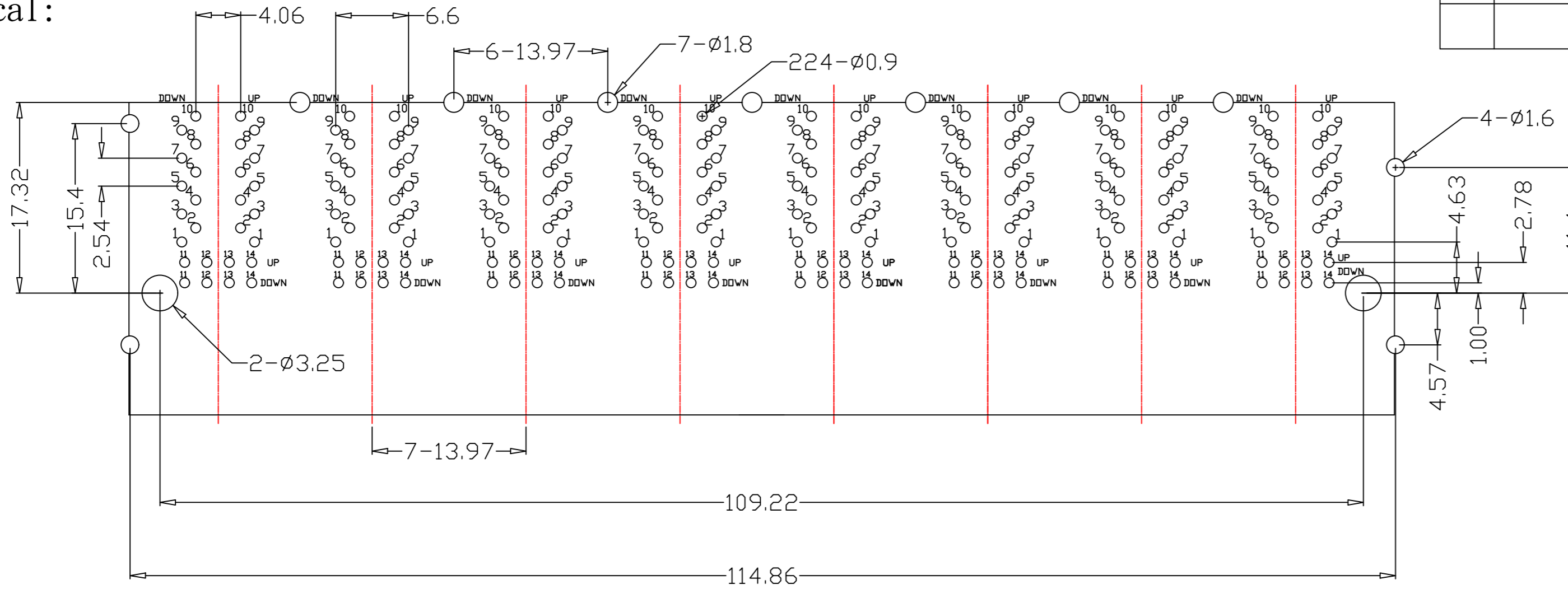

RECOMMENDED PCB LAYOUT COMPONENT SIDE  
ALL DIMENSION TOLERANCE ARE ±0.05 UNLESS OTHERWISE SPECIFIED

PROFILE OF WAVE SOLDER :

1. Peak temperature ( $T_p$ ) :  $250^{\circ}\text{C} \pm 5^{\circ}\text{C}$ .
2. Peak temperature ( $T_p$ ) time: 5sec max.

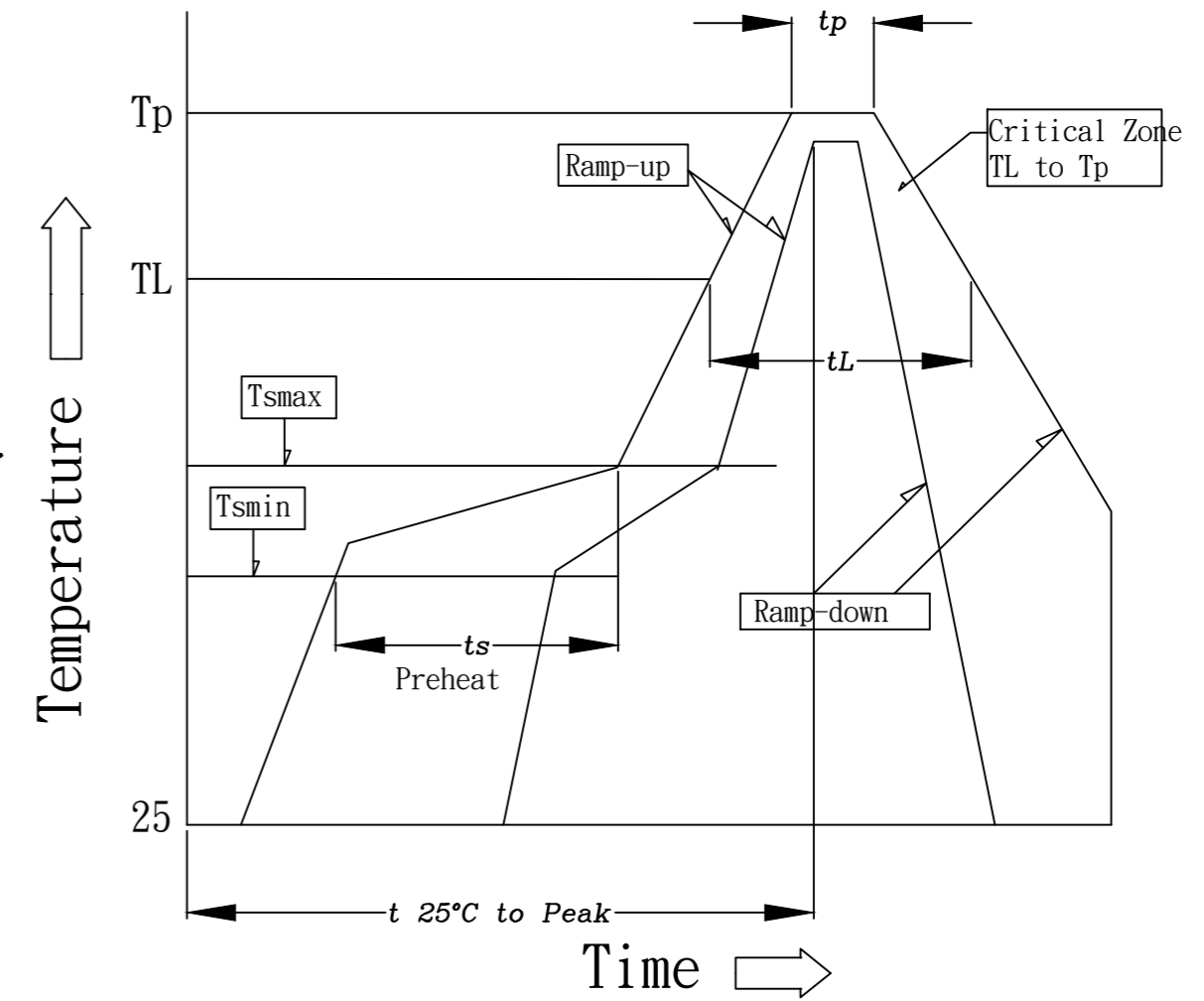

Environmental:

1. Storage Temp:  $-40^{\circ}\text{C}$  to  $+85^{\circ}\text{C}$ .
2. Operating Temp:  $0^{\circ}\text{C}$  to  $+70^{\circ}\text{C}$ .
3. MATES WITH MODULAR PLUG CONFORMING TO FCC PART 68, SUBPART F.

QC Inspection Item	DIMENSION IN mm [Inch]		<b>ELLAX CORPORATION</b>				
	TOLERANCE UNLESS OTHERWISE SPECIFIED					TITLE <b>2x8 2.5G Base-T</b>	
	.X ± 0.38	X.° ± 2.0°	DRAWING NUMBER 728EG2JSRA2				
	.XX ± 0.20	.X° ± 1.0°	DRAW KONGLEI 2018,10,04				
.XXX ± 0.10		APPROVE Corey 2018,10,04	CHECK Alen 2018,10,04	PROJ.  SHEET X OF Y	SCALE 1:1	SIZE A3	REV P1

RoHS Compliant

REV	MODIFICATION	DATE	DRAW	APPROVE

Schematic:

### Type EG2

ELECTRICAL CHARACTERISTICS AT +25°C UNLESS OTHER SPECIFIED  
MEETS IEEE 802.3 SPECIFICATION

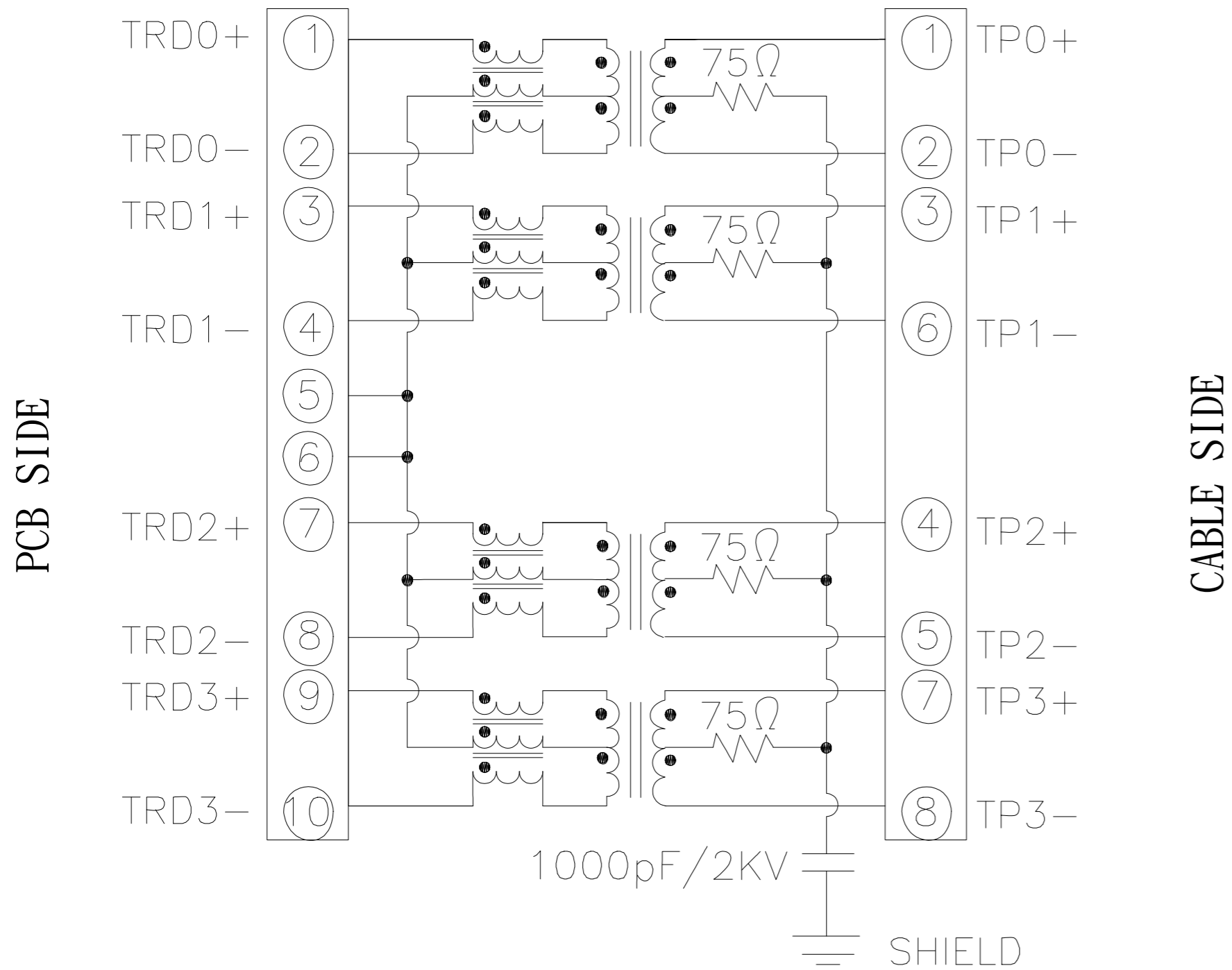

PARAMETER	SPECIFICATIONS	
OPERATING TEMPERATURE	0°C TO +70°C	
TURNS RATIO	1.00 ± 2%	
POLARITY	PER SCHEMATIC	
INSERTION LOSS (SDD21&SDD12)	1-50MHz	50-125MHz
	-0.5 dB MAX	-1.0 dB MAX
PHY-SIDE RETURN LOSS (SDD11-Zref=100 OHMS ± 1%)	1-40MHz	40-200MHz
	-20 dB MIN	-20+15*LOG <sub>10</sub> (f/40) dB MIN
LINE-SIDE RETURN LOSS (SDD22-Zref=100 OHMS ± 1%)	1-40MHz	40-200MHz
	-20 dB MIN	-20+15*LOG <sub>10</sub> (f/40) dB MIN
INDUCTANCE (OCL)	120 uH MIN @ 100KHz, 100mV	
CROSSTALK, ADJACENT CHANNELS (SDD21-ADJ.)	1-125MHz	
	-30 dB MIN	
COMMON MODE REJECTION RATIO (SCC21)	30-200MHz	
	-30 dB MIN	
COMM. TO DIFF REJECTION RATIO (SCC12)	10-125MHz	
	-45+f/35 dB MIN	
INPUT-OUTPUT ISOLATION	2250 VDC FOR 60 SECONDS	

NOTE: f IS FREQUENCY IN MHZ.

### LED CONFIGURATION

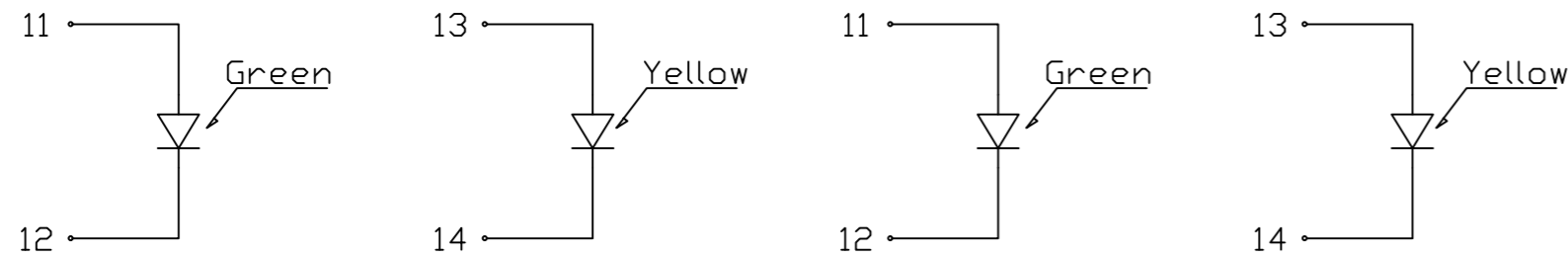

### Part Number:

728EG2JSRA2

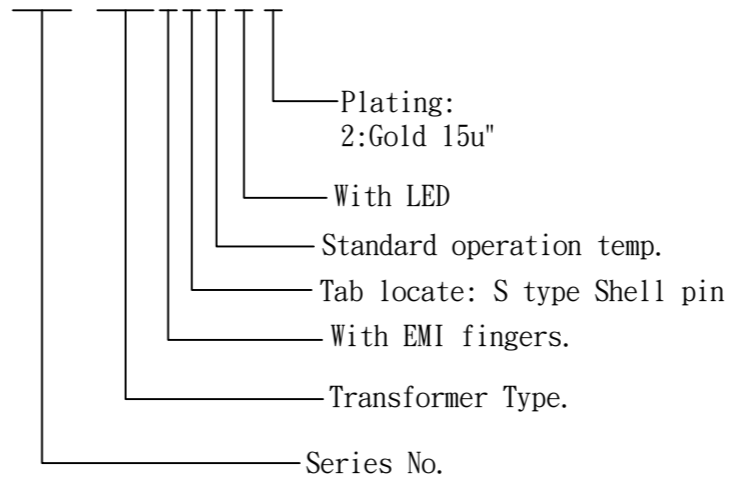

Code	RJ45 Plating			LED Code			
	Contact area	Solder tail	Under plating	Left LED		Right LED	
F	3u" gold	100u" Tin Min.	40u" Nickel Min.	A	Green	-	Yellow
1	6u" gold			B	Yellow	-	Green
2	15u" gold			C	Green	-	Green
3	30u" gold			D	-	Green	Yellow
4	50u" gold			E	-	Yellow	Green
				F	Yellow	-	Orange
				G	Orange	Green	Yellow
				L	Yellow	-	Green
				0	-	-	Orange

### Part Number:

XXX XXX XX X X X

① ② ③ ④ ⑤ ⑥

- ① Series No.
- ② Transformer Type.
- ③ Shield Type.
- ④ R=Standard operation temp. (0°C to +70°C)  
H=Industrial operation temp. (-40°C to +85°C)
- ⑤ LED Code: See left table.
- ⑥ RJ45 Plating

Inspection Item	DIMENSION IN mm [Inch]	<b>ELLAX CORPORATION</b>		
	TOLERANCE UNLESS OTHERWISE SPECIFIED	TITLE <b>2x8 2.5G Base-T</b>		
	.X ± 0.38   X.° ± 2.0°	DRAWING NUMBER 728EG2JSRA2		
	.XX ± 0.20   .X° ± 1.0°	DRAW KONGLEI 2018,10,04		
.XXX ± 0.10	APPROVE Corey 2018,10,04	CHECK Alen 2018,10,04	DRAW KONGLEI 2018,10,04	PROJ.  SHEET X OF Y SCALE 1:1 SIZE A3 REV P1